

## Standard Load Binder + Chain Sling (2-parted / 8-8)



**Item number:** 13-20080082-003500-010

**Description DE:** Dolezych Zurrspannkette PowerLash "Standard"; 2-teilig; DIN EN 12195-3; zulässige Zugkraft (LC): 4.000 daN; Ketten-Nenngröße: 8; Ketten-Güteklasse: 8; Nennlänge L1: 3.500 mm

**Description EN:** Dolezych lashing chain PowerLash "Standard"; 2-part; DIN EN 12195-3; Lashing Capacity (LC): 4,000 daN; Chain nominal size: 8; Chain quality class: G80; Nominal length L1: 3,500 mm

### Technical characteristics:

Lashing Capacity (LC)	4.000 daN
Standard Tension Force (STF)	1.000 daN
Nominal Length (L1) (ratchet load binder closed)	3.500 mm
H-stemp	No
Chain nominal size	8
Chains quality class	8 / G80
Norm	DIN EN 12195-3
Clamping distance	≈ 155 mm
Chain	Round steel chain (black)
Shortening element	Clevis grab hook with safety pin
End hook	Clevis hook
Ratchet Load Binder	Standard (G80)

### System components:

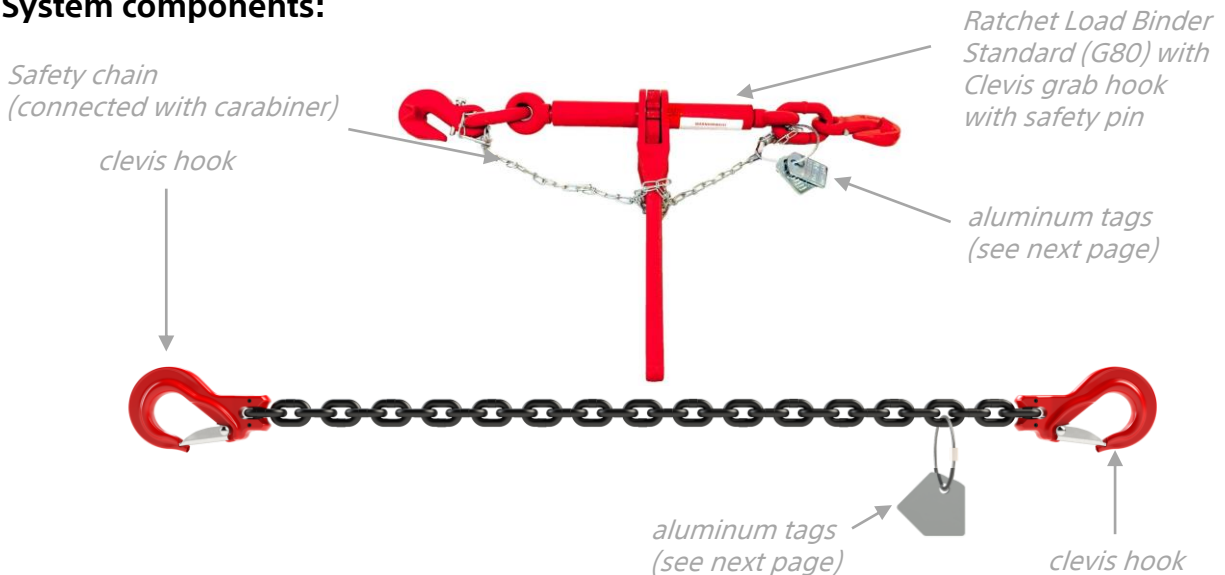

**List of integrated components:**

Ratchet load binder: 8-8

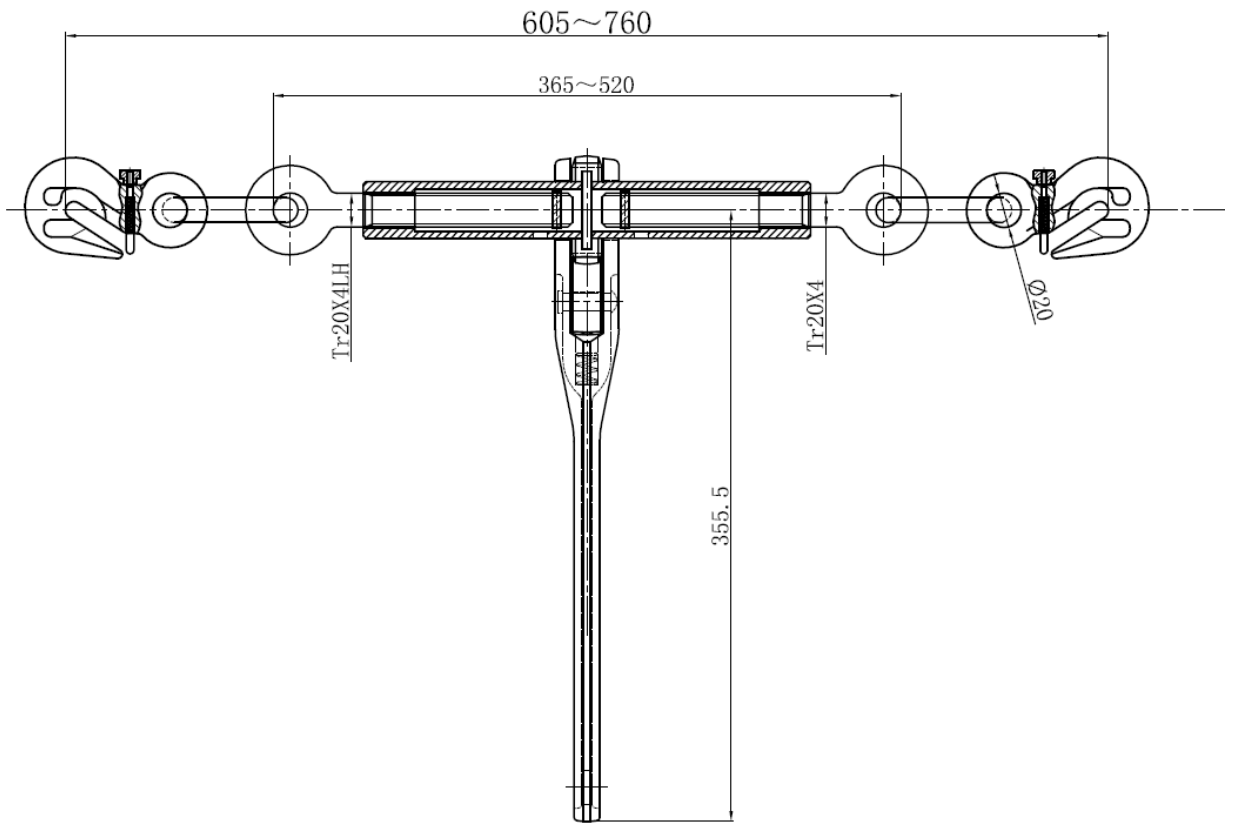

Clevis hook: 8-8

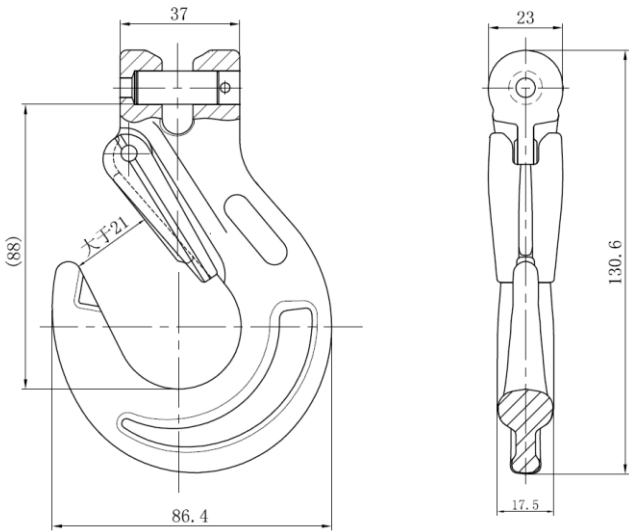

Clevis grab hook with safety pin: 8-8

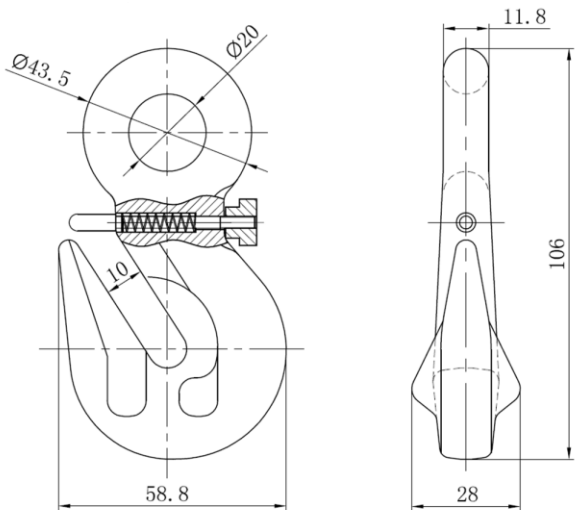

## Label with aluminum tag:

### Identification plate at the chain

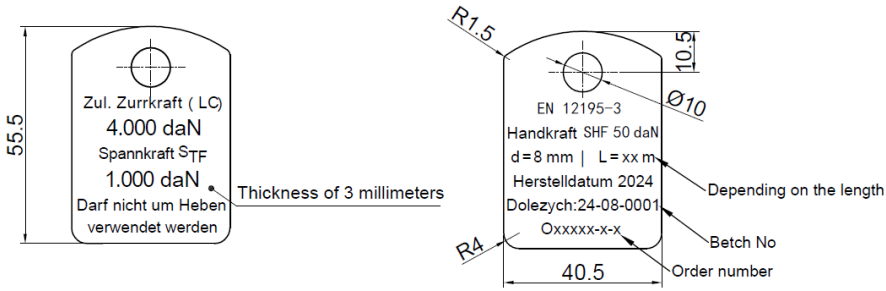

### Identification plate at the ratchet load binder

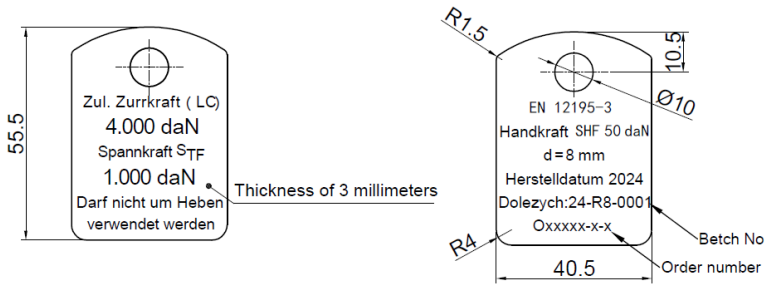

### Inspection plate at the chain & at the ratchet load binder



### Sticky note:

- Must be glued to every ratchet load binder
- The value is the maximum length that the threads can be turned out

## WARNHINWEIS!

Audrehsicherung nicht überdrehen -  
75 mm pro Seite

Ein Überdrehen kann zur irreparablen  
Beschädigung des Ratschlastspanners führen

### Cardboard box:

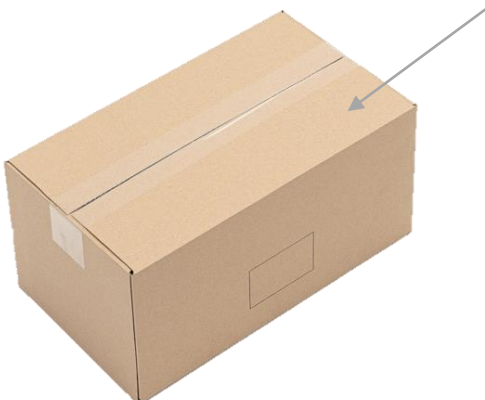

#### Imprint on every box:

Art.-Nr.: 13-20080082-003500-010

Zurrspannkette 8-8  
PowerLash „Standard“  
2-teilig

DD 24-08-0002

*Batch No  
(Same on Identification plate)*

Stückmenge: 1

*Number of products  
in the box*