

Standard Load Binder + Chain Sling (1-parted / 8-8)

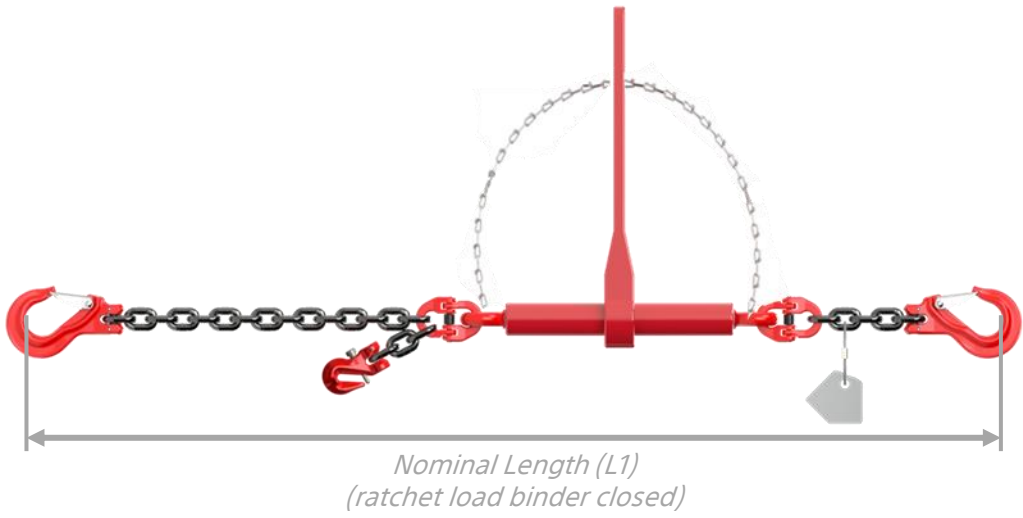

Item number: 13-20080081-003500-010

Description DE: Dolezych Zurrspannkette PowerLash "Standard"; 1-teilig; DIN EN 12195-3; zulässige Zugkraft (LC): 4.000 daN; Ketten-Nenngröße: 8; Ketten-Güteklasse: 8; Parallelhaken; Nennlänge L1: 3.500 mm

Description EN: Dolezych lashing chain PowerLash "Standard"; 1-part; DIN EN 12195-3; Lashing Capacity (LC): 4,000 daN; Chain nominal size: 8; Chain quality class: G80; parallel hook; Nominal length L1: 3,500 mm

Technical characteristics:

Lashing Capacity (LC)	4.000 daN
Standard Tension Force (STF)	1.000 daN
Nominal Length (L1) (ratchet load binder closed)	3.500 mm
H-stemp	No
Chain nominal size	8
Chains quality class	8 / G80
Norm	DIN EN 12195-3
Clamping distance	≈ 155 mm
Chain	Round steel chain (black)
Shortening element	Clevis grab hook with safety pin
End hook	Clevis hook
Ratchet Load Binder	Standard (G80)

System components:

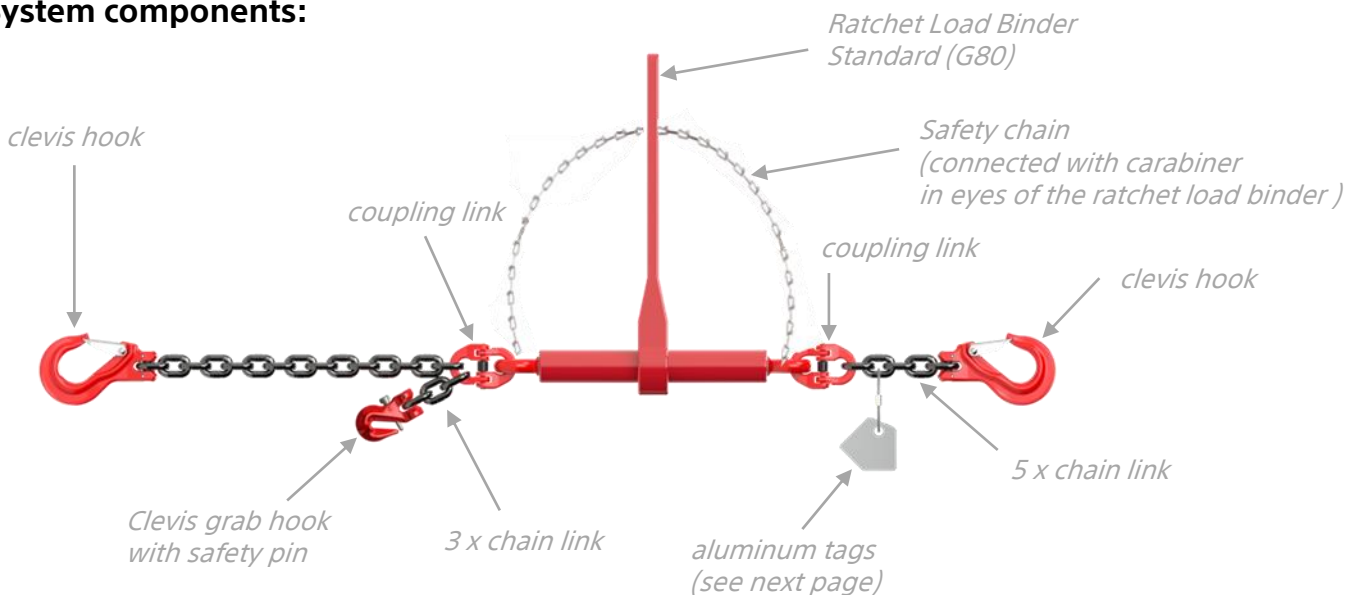

List of integrated components:

Ratchet load binder: 8-8

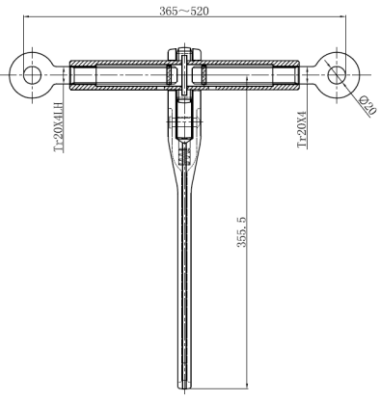

Clevis hook: 8-8

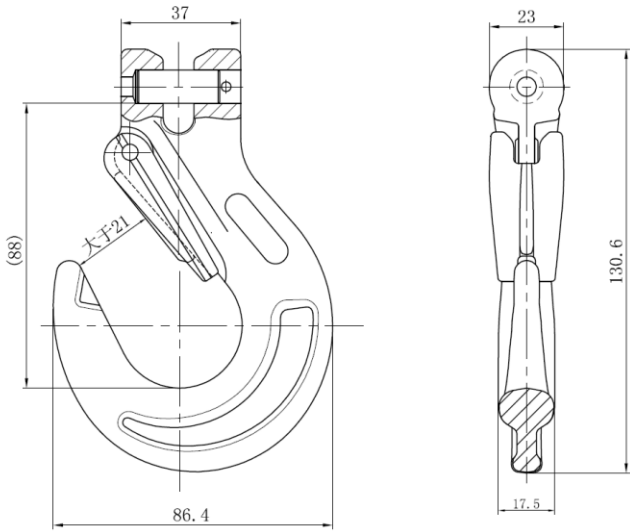

Coupling Link: 8-8

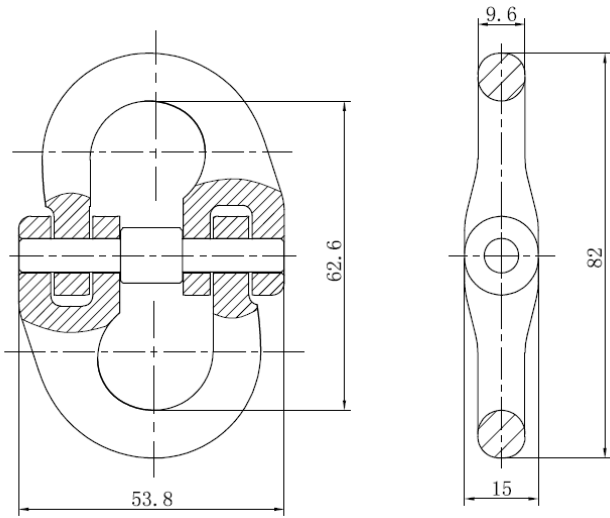

Clevis grab hook with safety pin: 8-8

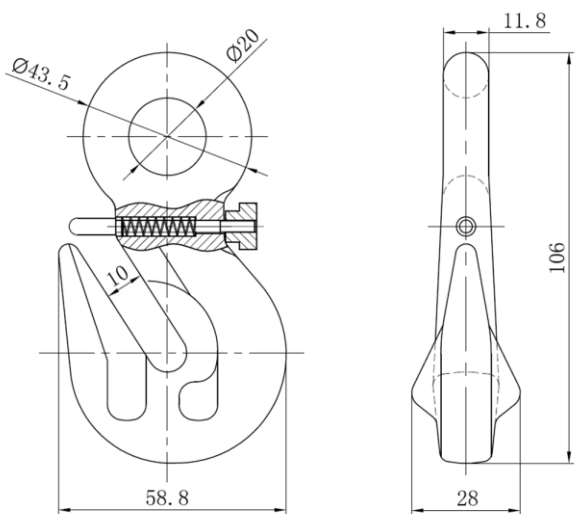

Label with aluminum tag:

Identification plate

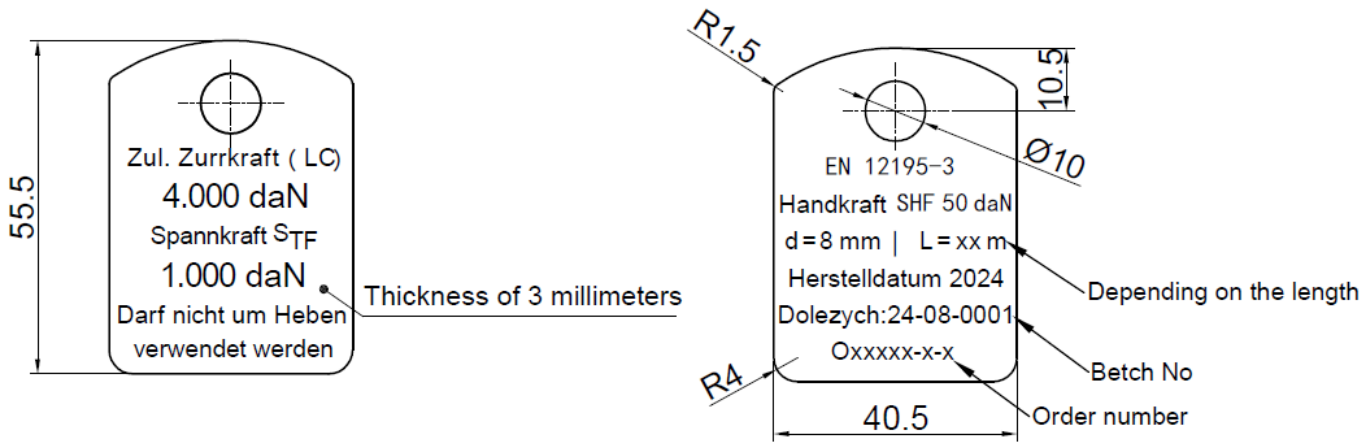

Inspection plate:

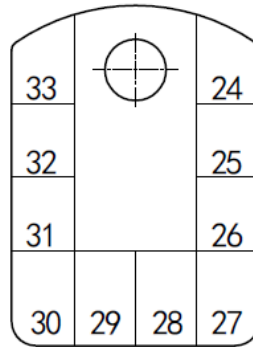
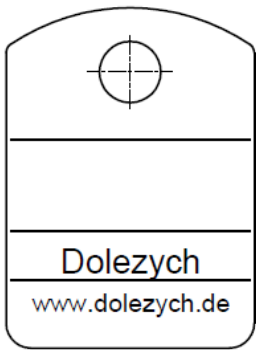

Sticky note:

- Must be glued to every ratchet load binder
- The value is the maximum length that the threads can be turned out

WARNHINWEIS!

Audrehsicherung nicht überdrehen -
75 mm pro Seite

Ein Überdrehen kann zur irreparablen
Beschädigung des Ratschlastspanners führen

Cardboard box:



Imprint on every box:

Art.-Nr.: 13-20080081-003500-010

Zurrspannkette 8-8
PowerLash „Standard“
1-teilig

DD 24-08-0001

Stückmenge: 1

Batch No

(Same on Identification plate)

*Number of products
in the box*