

Standard Load Binder + Chain Sling (2-parted / 10-8)



Item number: 13-20080102-003000-010

Description DE: Dolezych Zurrspannkette PowerLash "Standard"; 2-teilig; DIN EN 12195-3; zulässige Zugkraft (LC): 6.300 daN; Ketten-Nenngröße: 10; Ketten-Güteklasse: 8; Nennlänge L1: 3.000 mm

Description EN: Dolezych lashing chain PowerLash "Standard"; 2-part; DIN EN 12195-3; Lashing Capacity (LC): 6,300 daN; Chain nominal size: 10; Chain quality class: G80; Nominal length L1: 3,000 mm

Technical characteristics:

Lashing Capacity (LC)	6.300 daN
Standard Tension Force (STF)	1.575 daN
Nominal Length (L1) (ratchet load binder closed)	3.000 mm
H-stemp	No
Chain nominal size	10
Chains quality class	8 / G80
Norm	DIN EN 12195-3
Clamping distance	≈ 155 mm
Chain	Round steel chain (black)
Shortening element	Clevis grab hook with safety pin
End hook	Clevis hook
Ratchet Load Binder	Standard (G80)

System components:

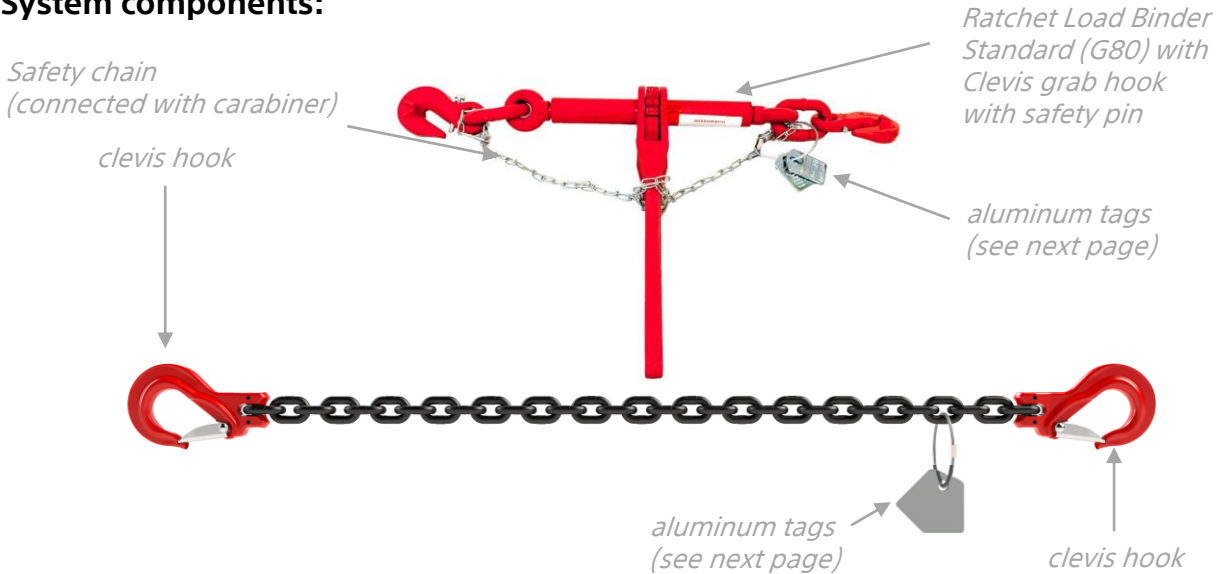

List of integrated components:

Ratchet load binder: 10-8

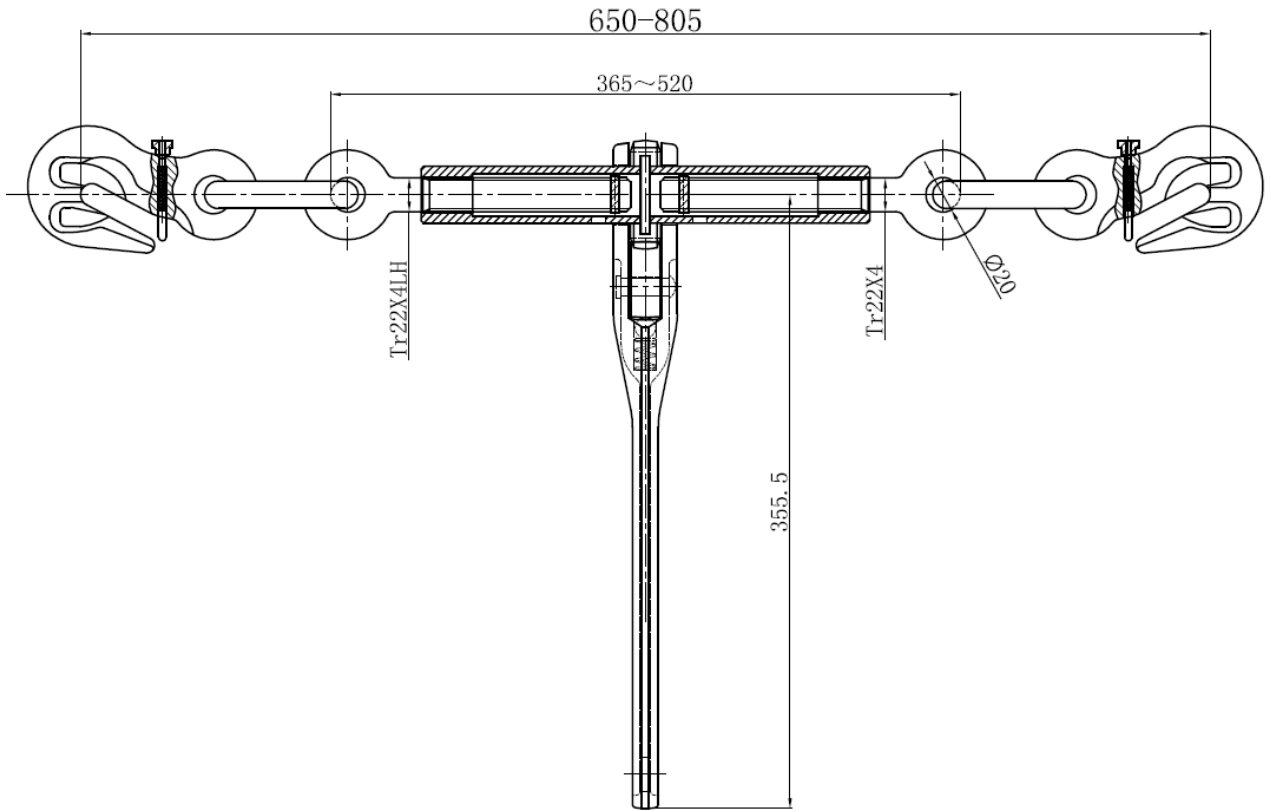

Clevis hook: 10-8

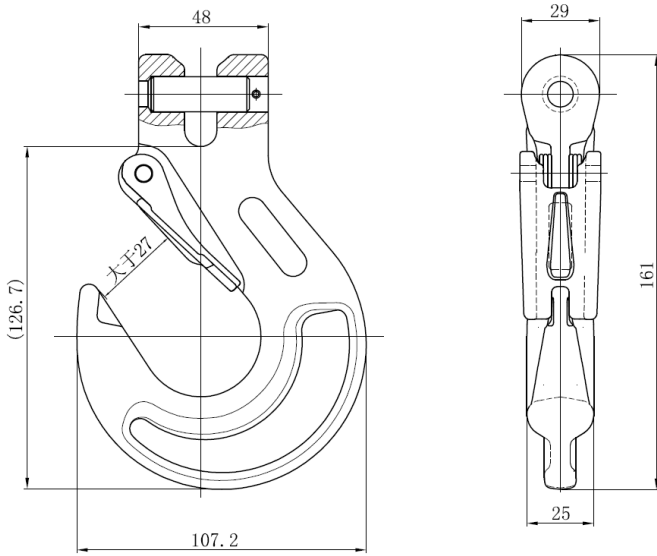

Clevis grab hook with safety pin: 10-8

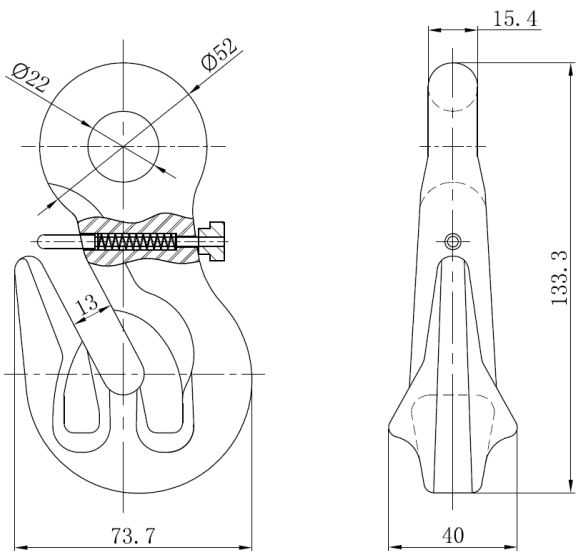

Label with aluminum tag:

Identification plate at the chain

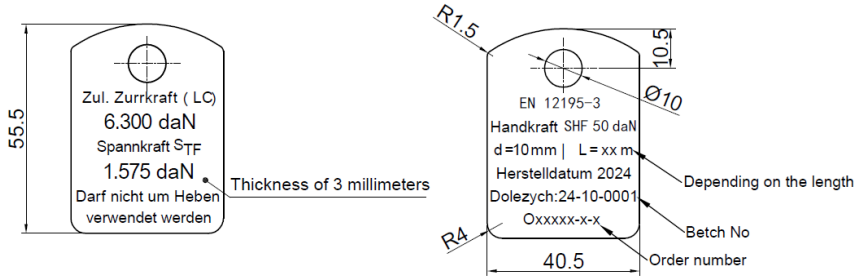

Identification plate at the ratchet load binder

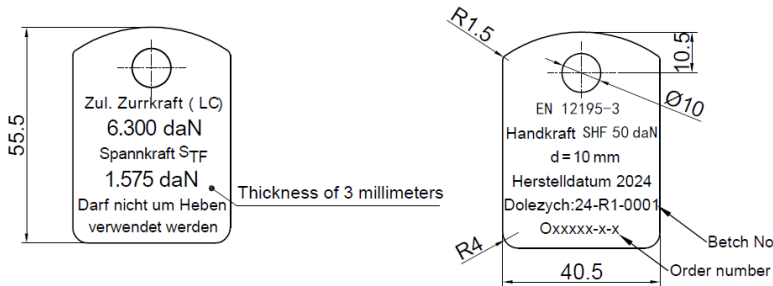

Inspection plate at the chain & at the ratchet load binder



Sticky note:

- Must be glued to every ratchet load binder
- The value is the maximum length that the threads can be turned out

WARNHINWEIS!

Audrehsicherung nicht überdrehen -
75 mm pro Seite

Ein Überdrehen kann zur irreparablen
Beschädigung des Ratschlastspanners führen

Cardboard box:



Imprint on every box:

Art.-Nr.: 13-20080102-003000-010

Zurrspannkette 10-8
PowerLash „Standard“
2-teilig

DD 24-10-0002

Stückmenge: 1

*Batch No
(Same on Identification plate)*

*Number of products
in the box*